



Everything
from one source

SILCA[®] Insulating material

for fireplace and tiled stove construction
as well as preventive fire protection



SILCA® 250KM



The established calcium silicate insulation board for fireplace and tiled stove construction

Over the past years CASITHERM/SILCA has been the only German producer of calcium silicates to show that with innovative products you can continuously improve both the safety and productivity in the assembly of fireplaces. Our guarantee is the close contact to specialist craftsmen and the specialized trade and our treasure trove of experience obtained in the course of time, not least in the insulation in the industrial sector.

For many years furnace constructors inside and outside Europe have relied on the **SILCA® 250KM** calcium silicate insulation board authorized by the **Deutsche Institut für Bautechnik Berlin** (German Institute for Civil Engineering), **national technical approval nro. Z-43.14-117**. The test results for the determination of the equivalent thicknesses according to the technical rules of the tiled stove and air heating building trade are shown in the following diagrams.

SILCA® 250KM is a real European champion. Thus the **VKF Vereinigung Kantonalen Feuerversicherungen** (Association of Swiss Cantonal Fire Insurance Underwriters) issued the **Swiss Fire Prevention Approval no. 15202**, the biggest Scandinavian research institute **SINTEF** issued **certificate no. 120-0238**, and for sure our **SILCA® 250KM** insulation board also achieves the results required by the new Austrian standard **Ö-Norm B8311** in its issue 2013-12-15. Across the borders this means safety and untroubled pleasure in the building and heating of domestic fire places. According to standard **EN 14 306:2010** **SILCA® 250KM** received the certificate no. 0432-CPD-420002242/2-6.

SILCA® 250KM replaces both, fire protecting wall and thermal insulation, in only one construction material and not only for this reason guarantees more favorable results than comparable products. The required thickness of the insulation layer is determined on the basis of the assembly instructions of the stove manufacturers, the technical rules TR-OL and further national regulations. Depending on the individual case of application and where appropriate, an active air ventilation has to be provided.

The main components of the SILCA calcium silicate boards are lime and sand. These are physiologically safe and

classified as environmentally compliant construction material. This is guaranteed by our modern production facilities, permanent quality control, external supervision and certification according to **DIN EN ISO 9001: 2008**. The environmental compatibility is certified by the environmental product declaration according to **ISO 14025** and **EN 15804** issued by the **Institut Bauen und Umwelt e.V.** (German institute for construction and environment), declaration nro. **EPD-CSP-2013111-D**.

The boards are pressed on one of the world's largest filter presses for the production of calcium silicates to a dimension of **3,000 x 1,250 mm**. The standard dimensions are **1,250 x 1,000 mm**, **1,250 x 500 mm** and **1,000 x 625 mm**. The standard thicknesses range from **30 mm** to **100 mm**. A further quality feature of the SILCA calcium silicate boards is the firm and dust-free moulding skin. Therefore, a further field of application is the lining of fireplaces.

Apart from the standard dimensions individual cuts can be produced directly in the plant on demand. **SILCA® 250KM** can be treated with standard wood machining tools and also be screwed on assembling. For further information on the assembly of our **light construction flue shaft SILCA® LC90** we refer to our special brochure.

Your advantages at a glance

- Space saving due to thin insulation thickness
- Non-combustible
- Environmentally compliant construction material
- Physiologically safe
- Fire protecting wall and thermal insulation in one single construction material
- Large-size boards
- Easy handling and assembling
- Easy disposal as building waste
- Applicable for insulation and construction

MADE IN GERMANY

Material Description	SILCA® 250KM
Approval in Germany	National technical approval no Z-43.14-117
Approval in Switzerland	valid for fireplace and tiled stove construction
Approval SINTEF NBL	Fire Prevention Approval no. 15202
Fire resistance	120-0238 (50 mm)
CE-Certificate	EI 120 (80 mm), DIN EN 13501-2
Reaction to fire	0432-CPD-420002242/2-6
Bulk density ($\pm 10\%$)	Non-combustible A1
Porosity	250 kg/m ³
Compressive strength	approx. 90 %
Thermal resistance (board thickness 40 mm)	$\geq 0.5 \text{ m}^2 \text{ K/W}$
Thermal conductivity at 200 °C	$< 0.1 \text{ W/mK}$
Thermal expansion at 500 °C	$< 0.2\%$
Standard dimensions in mm	3,000 x 1,250; 2,000 x 1,250; 1,250 x 1,000; 1,250 x 500; 1,000 x 625; 625 x 500
Standard thicknesses in mm	30–100



For application according to the regulations of the tiled stove and air heating trade

a) As substitute for thermal insulation

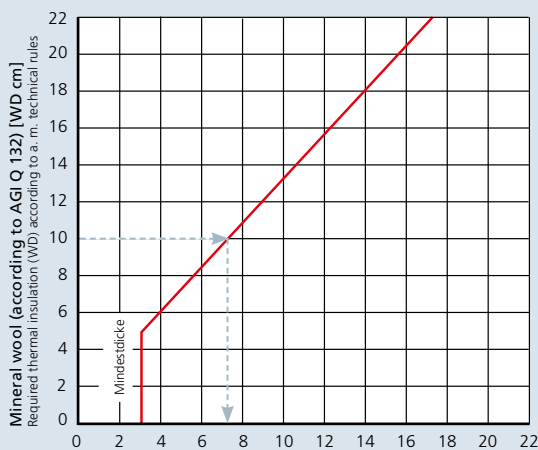

Example:
Required thermal insulation (WD) with mineral wool (according to AGI Q 132) according to manufacturer instruction: 10 cm

Corresponds to 7,3 cm SILCA® 250KM

b) As substitute for fire protecting wall and thermal insulation

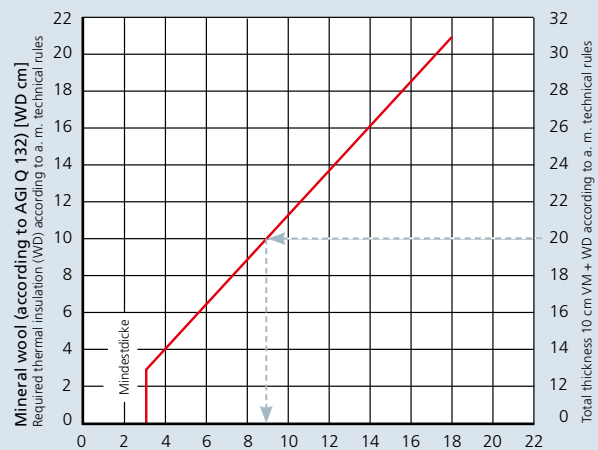

Example:
Required thermal insulation (WD) with mineral wool (according to AGI Q 132) according to manufacturer instruction: 10 cm
Required fire protecting wall (VM) according to technical regulations: 10 cm
Total thickness according to DIN 18895: 20 cm

Corresponds to 8,9 cm SILCA® 250KM

NEW now also available in thickness of 75 mm

SILCACON

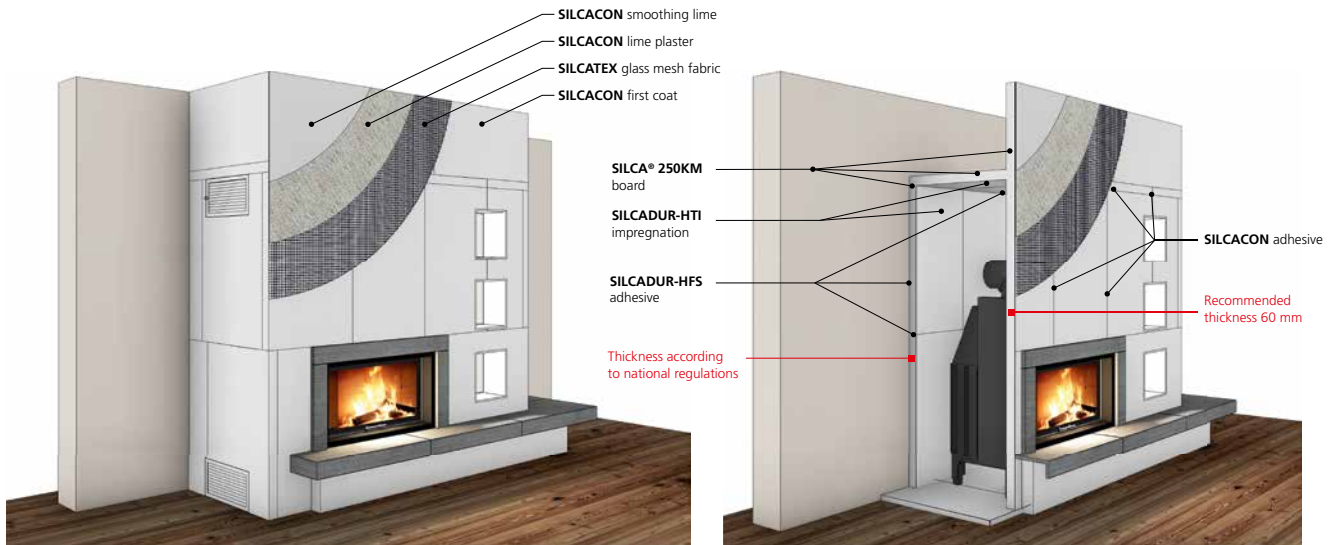

Plaster system for SILCA® 250KM insulation boards

SILCA® 250KM allows a fast, simple and safe lining of fireplaces with inactive surface. According to the customer's desire SILCA® 250KM may be plastered or decorated with natural stone or stove tiles.

In this case the large-sized insulation board is used as construction board and applied in the area of blankets, side claddings or wooden panels. Even special individual customer demands like e.g. the installation of flat screens can be easily realized. The separation distances within the heating chambers and the ventilation grids have to be executed according to the manufacturer instructions and technical rules.

The SILCACON system consists of different components which complement one another. Therefore, it meets the most different customers' desires regarding the surface finish.

SILCACON – simple, fast and safe lining of modern fireplaces!



Please have a look at our video at YouTube (search term: SILCA) which shows the construction technique of SILCA® 250KM/SILCACON
http://www.youtube.com/results?search_query=Silca

SILCACON adhesive

SILCACON adhesive is a high-quality adhesive mortar which is ready for use after mixing with water and hardens hydraulically. It is a pre-mixed hydraulically setting dry mortar with cement according to DIN 1164 and with high-quality filler additives which has to be mixed with clean water. It serves to bond SILCA® 250KM insulation boards applied in the exterior (cold) construction of fireplaces and tiled stoves.

Please make sure that **SILCACON adhesive** is **never** applied for the installation of **SILCA® 250KM insulation boards** in the interior stove. In order to obtain the required fire and heat protection of the protective wall from inside our **SILCADUR HFS adhesive** which is technically approved has to be applied in the interior stove.

SILCACON adhesive is also applicable to any mineral material for wall construction and grounds suitable for plaster, e. g. brickwork of materials with hydraulically hardened binders according to DIN 1164, DIN 1060, DIN 4211 as well as brickwork of natural materials which are standardised or approved by the construction supervising board according to DIN 1053 (e.g. porous concrete, common bricks and lime sand brick).

SILCACON adhesive



SILCACON first coat



SILCACON lime plaster natural white



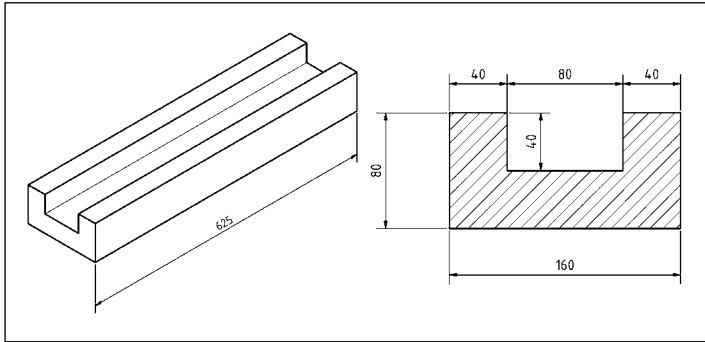

SILCA® U160

SILCA U160 is a moulded part out of SILCA® 250KM for the protection of wires and sensitive components inside modern fireplaces. The open cross-sectional area dimensioned 40 x 80 mm allows the subsequent installation or exchange of major connection assemblies.

The height of the moulded part of 625 mm facilitates a simple installation into the existing SILCA® 250KM insulation.

SILCACON first coat

SILCACON first coat/deep primer serves to treat the surface of the SILCA® 250KM insulation boards before applying the lime plaster and smoothing lime and should also be applied to the surface before bonding different boards. The first coat reduces the capillary activity of the SILCA® 250KM board and thereby slightly hardens the surface.

SILCACON first coat is died with clean water in a ratio of 1:2/1:3 and can be applied by brush, roll or spraying device. The treated surface becomes slightly blue, for further treatment the surface must be dry. The working environment must be sufficiently ventilated. As long as the first coat has not dried, the working equipment can be cleaned with water.

SILCACON lime plaster – natural white

SILCACON lime plaster with a grain diameter of 0 – 1,2 mm is applied to the surface of the boards pre-treated with SILCACON first coat and well dried. For the connection of boards and for general reinforcement we suggest inserting additionally SILCATEX-SE glass mesh fabric.

The lime plaster can be coated in one or two steps. The first plaster layer should be in a range of 5–10 mm. According to the certificate of national technical approval the maximum thickness of the total layer is specified to be 15 mm.

SILCACON smoothing lime – natural white

SILCACON smoothing lime can be applied either directly onto the first coated SILCA® 250KM board or as last layer onto the lime plaster in order to smooth the surface. The maximum thickness of layer is 1 mm; according to the certificate of national technical approval it is limited to a total thickness of 2 mm.

For further details regarding the handling of our SILCACON products please pay attention to our instructions on the corresponding packaging.

SILCADUR-HTI impregnation

SILCADUR-HTI is a high-temperature resistant impregnation for application on our calcium-silicate products for surface consolidation and dust bonding. The impregnation is inorganic, odour-neutral and suitable for additional surface treatment of the SILCA® 250KM boards in the heating chamber.

The impregnation is not suitable as first coat for subsequent plastering and bonding in the constructive area – for this application SILCACON first coat is to be applied.

SILCADUR-HTI is very easy to handle, it is ready for use and can be applied by brush or spraying device.

SILCATEX-SE glass mesh fabric

SILCATEX-SE glass mesh fabric is an e-glass with special finish for low-flammability and resistance to lateral movement. It serves to reinforce the plaster and concrete surface. SILCATEX-SE is alkali-resistant, dimensionally stable, and rot-proof and does not contain any caustic or irritating substances.

Classification temperature	550 °C
Decomposition of blackening	> 350 °C
Surface weight	approx. 165 g/m ²
Mesh width	4x4 mm
Roll dimension	50x1/10x1 m

SILCACON smoothing lime natural white



SILCADUR-HTI impregnation



SILCATEX-SE glass mesh fabric



SILCAWOOL

Bio-soluble products

SILCAWOOL is a high temperature fibre with an increased bio-solubility and is therefore an alternative to the established aluminium silicate wool (ceramic fibre). SILCAWOOL is a spun fibre on the basis of calcium magnesium silicate with high thermal stability, high tensile strength as well as good elasticity. Due to the high bio-solubility it is not classified as dangerous material and chemically less resistant than aluminium silicate wool.

SILCAWOOL fibres

SILCAWOOL fibres are converted into mats, boards, paper and cords or delivered as loose wool.

SILCAWOOL Board 1100-350

SILCAWOOL Boards 1100-350 are solid insulation boards consisting of SILCAWOOL fibres with selected inorganic filling materials and organic and inorganic bonding materials. Due to their light weight they have low heat storage. They can be treated with a cutter knife very easily and with little dust only. The boards are used in industrial furnace construction but also especially in the tiled stove construction. They are recommended by the **Österreichischer Kachelofenverband (Austrian Tiled Stove Association)** as upper combustion chamber insulation board for **UmweltPlus Brennraum** according to UZ37.

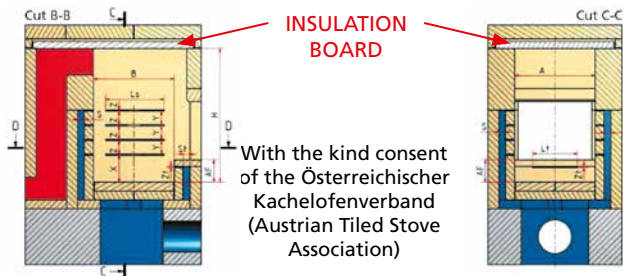

Classification temperature	1,100 °C
Bulk density ($\pm 10\%$)	approx. 350 kg/m ³
Linear shrinkage 24 h – 1,100 °C	< 1.5 %
Glowing loss at 1,100 °C	approx. 5.5 %
Thermal conductivity at 600 °C	0.12 W/mK
Dimensions in mm	1,000x610x30

SILCAWOOL 120P bio-soluble mats

SILCAWOOL mats are characterized by good tensile strength, are needled on both sides and have no organic bonding materials with unpleasant odour. They provide certain elasticity, e. g. as expansion gap between heating gas flues and tiled wall or other movable components.

Classification temperature	1,200 °C
Bulk density ($\pm 10\%$)	128 kg/m ³
Dimensions in mm	14,640x610x13 7,320x610x25 5,500x610x6

SILCAWOOL 120 paper

SILCAWOOL 120 Paper contains an acrylic bonding agent. Apart from the standard material we also deliver ready-cut stripes with an organic self-adhesive film on one side for easy assembling. These serve primarily as elastic separation between the refractory material and the metallic built-in components such as support frames.

SILCAWOOL 120 Paper Standard dimensions in mm	3x1,000x10,000 4x1,000x10,000 5x1,000x10,000
Stripe dimensions in mm (self-adhesive)	10,000x50x5 (further dimensions on request)

SILCAVER 55 tapes

SILCAVER 55 tapes are used in different applications for thermal separation or sealing. They are available in white and black colour. Furthermore, for easy assembling we also offer the tapes with an organic self-adhesive film on one side.

Standard dimensions	Thickness	2/3 mm
	Roll width	10/20/50 mm
	Roll length	50 m

SILCAWOOL 120P bio-soluble mats



SILCAWOOL paper – self-adhesive



SILCAVER 55 tapes

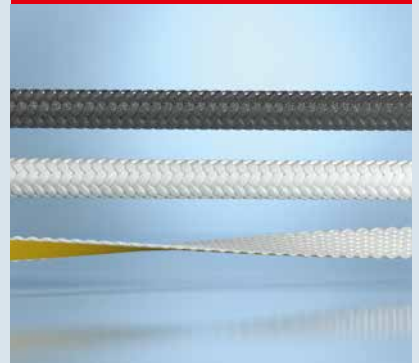

SILCAVER 55 sealing cords for ovens

SILCAVER sealing cords consist of e-glass and are available in different qualities, e.g. as braided cord with soft core in solid plaited packing (square or round). The softer knitted quality is

mostly used in fireplaces and tiled stoves construction. It is available in white and black colour. A further quality is a twisted cord lace-made with brass wire.

Classification temperature	550 °C	
Quality	Diameter	Length
Twisted cord lace-made with brass wire	6/8/10/12/15 mm	6–12 mm = 100 m 15 mm = 50 m 20 mm = 25 m 25+30 mm = 10 m
Knitted cord, black	6/8/10/12/15/	
Knitted cord, untreated (white)	20/25/30 mm	

SILCADUR-HFS adhesive

SILCADUR-HFS adhesive is used as bonding material for SILCA® 250KM boards. The adhesive is provided ready-to-use in buckets or tubular bags and can be applied directly after stirring or kneading. For further details regarding handling, storage etc. please pay attention to our bonding instructions on the corresponding packaging of the boards.

Classification temperature	950 °C
Package size	Bucket: 6.5 kg Bag: 850 g
Frost-free storage in closed package	18 months
Working temperature	10–25 °C

SILCADUR-CSMH adhesive

SILCADUR-CSMH is a repair adhesive on inorganic basis with a classification temperature of 1,300 °C. It serves for the bonding of dense calcium silicates and other mineral building materials among each other as well as for repairing cracks, fractures, etc. in refractory and vermiculite material within the fireplace.

The drying time depends on the layer thickness and the environment (temperature, humidity). In general, the drying time should not take less than 24 hours and the subsequent heating-up has to be effected slowly. In case that the adhesive

is not completely hardened, steam bubbles may occur on heating-up. SILCADUR CSMH adhesive is available in resealable cans of 500 ml and in cartridges of 310 ml.

SILCASIL 320 high-temperature silicone

SILCASIL 320 has an excellent adhesive strength and a high temperature-resistance up to 320 °C. It is used for sealing and bonding, e.g. for the bonding of cords or tapes. It can be applied on most firm, clean and dust-free surfaces, e.g. metal, ceramics or mineral materials. Exposure to high temperature is only permitted after complete hardening auf SILCASIL 320. The product is available in resealable tubes of 100 ml and cartridges of 310 ml.

Temperature resistance	max. 320 °C (1,000 h)
Density at 20 °C	1.15 g/cm ³
Hardness	20 Shore A
Working temperature	5–40 °C
Film formation on surface	after 10 minutes
Hardening, layer thickness 3 mm	after 24 hours
Colour	grey
Packing unit	100 ml tubes, 310 ml cartridges

SILCADUR-HFS adhesive



SILCADUR-CSMH adhesive



SILCASIL 320 high-temperature silicone





Everything from one source

The production plant in Paderborn-Sennelager



SILCA insulation boards are produced by Calsitherm Silikatbaustoffe GmbH in Paderborn-Sennelager.

The products are commercialized by our subsidiary company SILCA Service- und Vertriebsgesellschaft für Dämmstoffe mbH.

With more than 30 years of experience in the production of calcium silicate boards of different qualities and for multiple applications in industry and preventive fire protection Calsitherm is one of the leading producers of light and heavy calcium silicate and at the same time the only producer with a production made in Germany.

Flexibility and prompt reaction to our customer's requirements are the characteristics of Calsitherm. Our excellent quality together with the corresponding external supervision and the CE-certification for the SILCA boards guarantee our customers a very high standard of security.

SILCA is member of

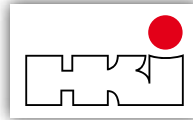

Your retailer in charge

For detailed information and detailed technical data sheets please see our homepage or our complete catalogue.

The properties indicated in this brochure are typical values obtained in serial testing and determined by acknowledged test methods. Product-specific spreading of results should be taken into account. The details provided in this brochure do not represent guaranteed properties and cannot be used for any warranty claim. The information is subject to technical modifications.

SILCA Service- und Vertriebsgesellschaft für Dämmstoffe mbH
P.O. box 20 02 65, 40811 Mettmann | Auf dem Hüls 6, 40822 Mettmann
Germany | Phone: +49 2104 9727-0, Fax: +49 2104 76902
info@silca-online.de

www.silca-online.de

